



# Furniture Catalogue

VOL 14 2018

WORKSTATIONS - FURNITURE - SEATING - STORAGE - ACCESSORIES

[WWW.RAPIDLINE.COM.AU](http://WWW.RAPIDLINE.COM.AU)

**rapidline**  
FURNITURE FOR TODAY



## WELCOME TO THE VOLUME 14 RAPIDLINE CATALOGUE

The catalogue aims to provide a comprehensive furniture range from which you can completely furnish your office - from home office to multiple workstation fit outs.

All products are selected from Sedex compliant factories around the globe and supported by full commercial warranties. Our product development team strives to establish and maintain high quality standards and selects recognised certified bodies such as AFRDI, BIFMA and GREENGUARD with as many products as possible.

The product is only part of the story - Rapidline product is supported by:  
Privately-owned and managed distribution centres across Sydney, Melbourne, Brisbane and Perth  
Full delivery and installation service  
National customer service teams  
In house marketing and projects team  
Design and layout service

All Rapidline products and services are available from all good office furniture and office products retailers around Australia.

[WWW.RAPIDLINE.COM.AU](http://WWW.RAPIDLINE.COM.AU)

# CONTENTS

## VOLUME 14

### PAGES

4 - 6	RAPID INFINITY
7	RAPID WIRING
8 - 11	RECEPTION & LOUNGE
12 - 15	RAPID SCREEN
16 - 19	RAPID SPAN WHITE
20 - 23	RAPID SPAN BEECH
24 - 26	TABLES
27 - 30	HEIGHT ADJUSTABLE WORKSTATIONS
31	MONITOR ARMS
32 - 33	RAPID VIBE
34 - 35	RAPID WORKER
36 - 37	RAPID MANAGER
38 - 40	MESH CHAIRS
41 - 43	OPERATOR CHAIRS
44 - 45	VISITOR CHAIRS
46 - 47	EXECUTIVE CHAIRS
48	CONFERENCE & EVENTS
49	HOSPITALITY
50	OTTOMANS
51	ACCESSORIES
52 - 56	STEEL STORAGE

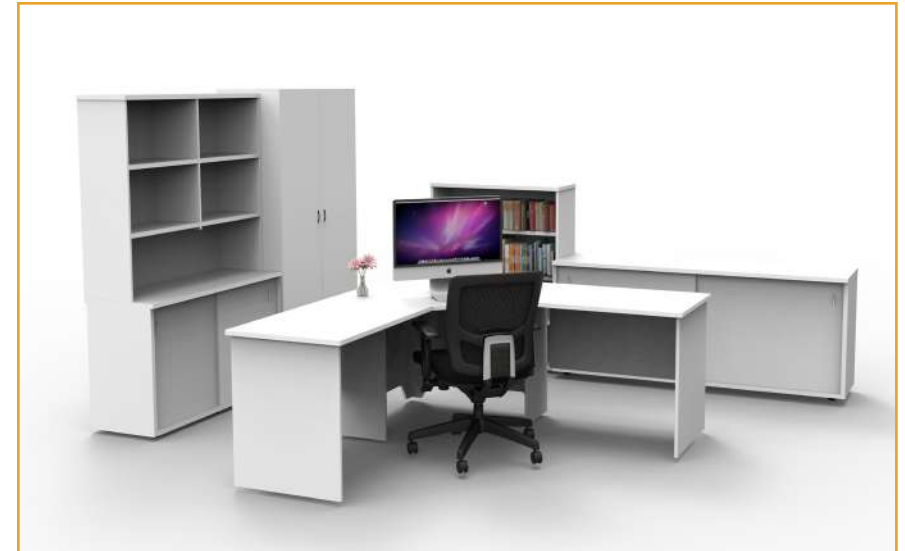

# RAPID INFINITY

The Rapid Infinity Bench Workstation System



Select the Loop End Leg for a Distinctive, Premium Finish.

Pinable Black Screen provides Privacy whilst also Reducing Noise.

ASK FOR A QUOTE & FLOOR PLAN

Profile 60 x 30mm End Leg Creates Simple, Clean Lines.



Double Telescopic Rail for Rigid Support.

Recessed Intermediate Leg for Maximum Leg Space.

Choose from the Profile or Loop Leg.



## Rapid Infinity

Maximise floor space and leg room with the stylish Rapid Infinity bench workstation system. Choose between two different end leg styles and include screens to create clean, space efficient workstation runs suitable for single, up to large numbers of users.



### WORKSTATION TOP SIZES

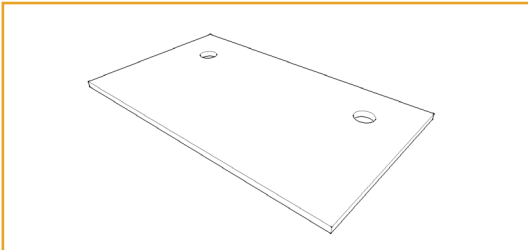

1200mm W x 700mm D x 25mm

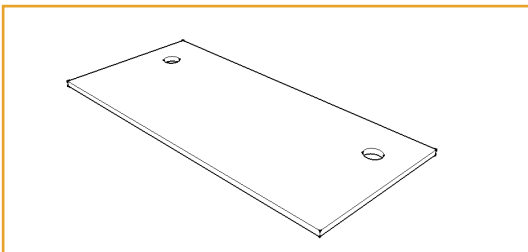

1500mm W x 700mm D x 25mm

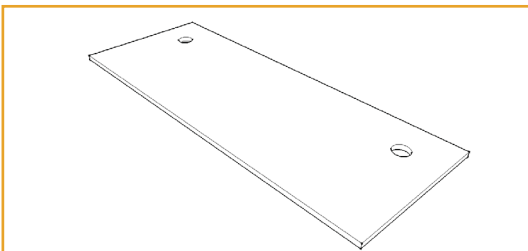

1800mm W x 700mm D x 25mm

### TOP COLOURS



Warm White



Beech

### SCALLOP TOP



Scallop Top without Cable Entry Holes  
1200mm W x 700mm D x 25mm  
1500mm W x 700mm D x 25mm  
1800mm W x 700mm D x 25mm



Brilliant White ONLY

### SCREENS



**IS700 B**  
T Return Screen  
690mm W x 20mm T x  
350mm H - Screw Fix

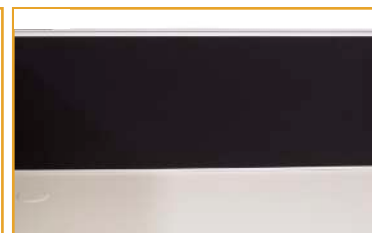

**IS1200 B, IS1500 B, IS1800 B**  
Pinable Black Screen  
Top W x 30mm T x 500mm H  
Black with White Frame

### SCREEN COLOURS



Black





▪ Single Sided, No Screens



▪ Single Sided with Screens



▪ Double Sided with Screens

## E1 ENVIRO BOARD

### WORKSTATION LEG SYSTEMS

Profile Leg - 60mm + 30mm



**PSL W** Single Profile Leg  
700mm W x 60mm D x 695mm H

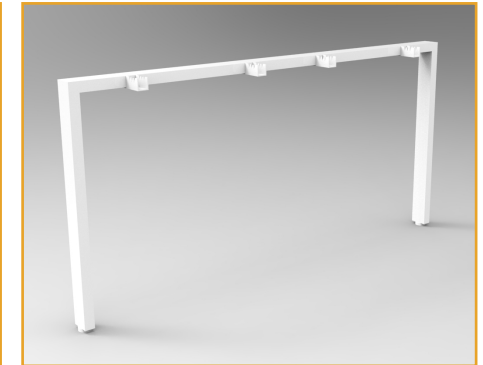

**PDL W** Double Profile Leg  
1430mm W x 60mm D x 695mm H

Loop Leg - 60mm + 45mm



**LSL W** Single Loop Leg  
700mm W x 45mm D x 695mm H

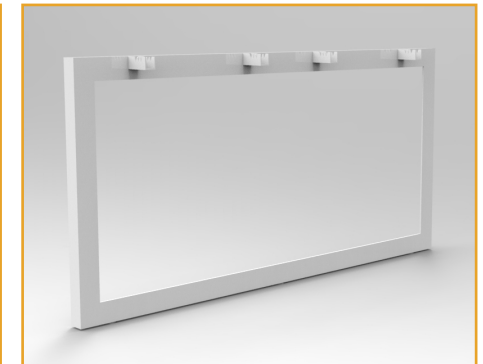

**LDL W** Double Loop Leg  
1430mm W x 45mm D x 695mm H



White Powdercoated Steel ONLY

## Cable Management Solutions

- Bringing power to the workstation.

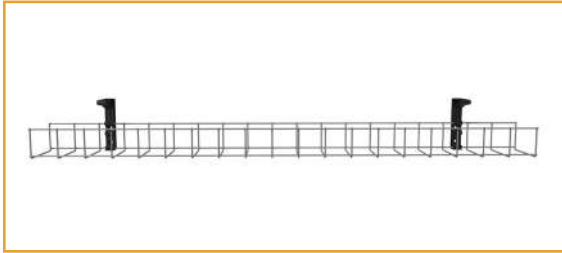

### Single Tier Cable Basket

- Under workstation cable tidy.



### Dual Tier Cable Baskets Kits

- Under desk, for power and data provisions.



### Power Rails

- Above desk power and data, clamps onto desk top.



### Flip Box

- In desk power and data, suits cut out size 220mm x 80mm. Choose from power only, power and data, or power and USB.



### In Desk Module - Use for Hot Desks

- Above desk power, data and double USB, fits in 80mm cable port.



### Pop Up Power - Use for Hot Desks

- Above desk power or power and USB. Suits cut out size 200mm x 100mm. Great for single workstations, hot desks and boardrooms.



### Power Pole Kits

- Run power and data from ceiling to workstation, or from ceiling to floor. Anodised finish, umbilicals also available.



### Boardroom Table Boxes

- Sits in table top, lid closes to obscure power and data points. Suits cut out 295mm x 148mm. Bead blasted natural finish.

# RECEPTION AND LOUNGE



## Reception and Lounge

The reception area is the bridge between your clients and management. Make the best possible first impression with a fresh, professional looking counter whilst allowing your visitors to wait in comfort with a range of fantastic soft seating designs.

**E1 ENVIRO BOARD**



WHITE 2000 COUNTER WITH RETURN



Brilliant White ONLY  
**W2RCW** 2200W X 780D X 1045H  
**W2RW** Return 1000W x 600D x 730H

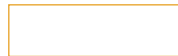

Brilliant White

WHITE 2000 COUNTER



Brilliant White ONLY  
 Glass Top Reception Unit  
**W2RCW** 2200W x 780D x 1045H



Brilliant White

MODULAR COUNTER

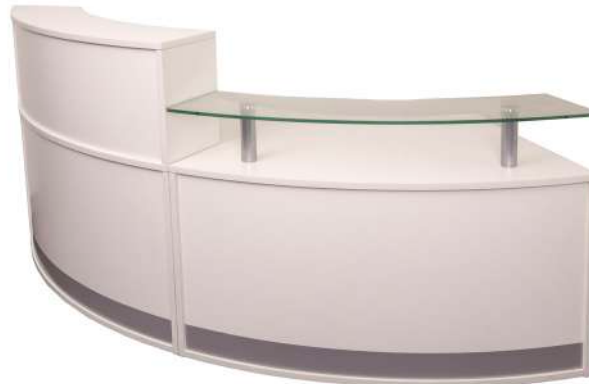

Modular Reception Counter with 2 Mix & Match Units  
 Warm White ONLY  
**MOD1W** Full Height Module 1339W x 872D x 1160H  
**MOD2W** Glass Top Module 1339W x 872D x 935H



Warm White

RC1809



**NEW**

Brilliant White with Black  
 Powdercoat Cowl and Kickplate  
**RC1809 BW** 1800W x 800D Workspace



Brilliant White



BEECH COUNTER WITH RETURN



E1 ENVIRO BOARD

FINISHES  
Beech



Available in Beech ONLY  
RWRC18 1800W x 762D x 1067H  
RWRCR11 Return 1066W x 610D x 1040H

BEECH COUNTER



Available in Beech ONLY  
RWRC15 1500W x 762D x 1067H  
RWRC18 1800W x 762D x 1067H

FLOW COUNTER



Available in Beech ONLY  
Curved Reception Counter with Glass Feature  
NCT1160 2400 x 1600 x 800D



# RECEPTION AND LOUNGE



## Reception and Lounge Chairs

Mix and Match the Splash Range in different fabric colours to brighten up any contemporary office space.

**Chair Dimension Codes**  
**SW** = Seat Width  
**SD** = Seat Depth  
**BH** = Back Height  
**GH** = Gas Height Range



**SPACE TUB 1**

SW	540mm	Compact Tub Chair for Small Spaces in PU Finish
SD	430mm	
BH	370mm	

**SPACE EXECUTIVE**

SW	480mm	Large Tub Chair with Flared Armrest Feature
SD	470mm	
BH	390mm	

**SPLASH CLUB**

SW	480mm	Tub Style with Gas Height Adjustment
SD	520mm	
GH	460-590mm	

**SPLASH CUBE**

SW	460mm	Contemporary Style with Chrome Sled Base
SD	520mm	
BH	330mm	

**SPLASH CONE**

SW	500mm	Circular Seat with Chrome Cross Base
SD	510mm	
BH	390mm	



**SPACE 1**

SW	550mm	Soft Black PU Finish, Stylish Frame
SD	515mm	
BH	310mm	

**SPACE 2**

SW	1110mm	Ideal for Reception or Meeting Areas
SD	515mm	
BH	310mm	

**SPACE 3**

SW	1670mm	PU Upholstery for Easy Maintenance
SD	515mm	
BH	310mm	

**SPACE 3**

SW	1670mm	PU Upholstery for Easy Maintenance
SD	515mm	
BH	310mm	

# RECEPTION AND LOUNGE

**Chair Dimension Codes**  
**SW** = Seat Width  
**SD** = Seat Depth  
**BH** = Back Height  
**GH** = Gas Height Range



ENTERPRISE 1

SW 530mm Comfortable  
 SD 510mm Blue Fabric  
 BH 320mm Upholstery



ENTERPRISE 2

SW 1010mm Mid Blue Finish  
 SD 510mm Adds Colour to  
 BH 320mm Any Space



ENTERPRISE 3

SW 1530mm Generous Size  
 SD 510mm with Chrome  
 BH 320mm Sled Base



VENUS 1

SW 630mm Classic Design,  
 SD 500mm Distinctive  
 BH 400mm Button Finish



VENUS 2

SW 1120mm Pair with  
 SD 500mm Matching  
 BH 400mm Ottoman



VENUS 3

SW 1770mm Ideal for  
 SD 500mm Reception or  
 BH 400mm Meeting Areas



VENUS OTTOMAN

SW 1030mm Use as an  
 SD 540mm Ottoman or  
 H 410mm Foot Stool



E1 ENVIRO BOARD

RAPID 50

Rapid 50 Coffee Table  
 White 50mm Frame  
 R5OCT 1200W x 600D x 450H



BLACK GLASS

Black Glass Coffee Table  
 AGT66 600W x 600D x 450H  
 AGT126 1200W x 600D x 450H



E1 ENVIRO BOARD

BUDGET

Budget Coffee Table  
 Ironstone Base  
 CT96 900W x 600D x 450H



E1 ENVIRO BOARD

CHROME BASE

Round 600mm DIA. Coffee  
 Table with Chrome Base  
 CCT6 600 DIA. x 425H

# RAPID SCREEN



## CREATE YOUR WORKSTATION ENVIRONMENT

We can help with consultation and planning to providing drawings or 3D rendered images of your design.



ASK FOR A QUOTE & FLOOR PLAN



## Rapid Screen Workstation System

Off the shelf, slimline workstation system with multiple configuration options. Slimline screen system with blue or grey screens in 1250mm or 1650mm heights. Choose between blue or grey fabric screens with warm white or beech desk tops. Select from different leg styles and colours to match your office workspace.



SCREEN COLOURS
Grey
Blue

TOP FINISHES
Beech
Warm White

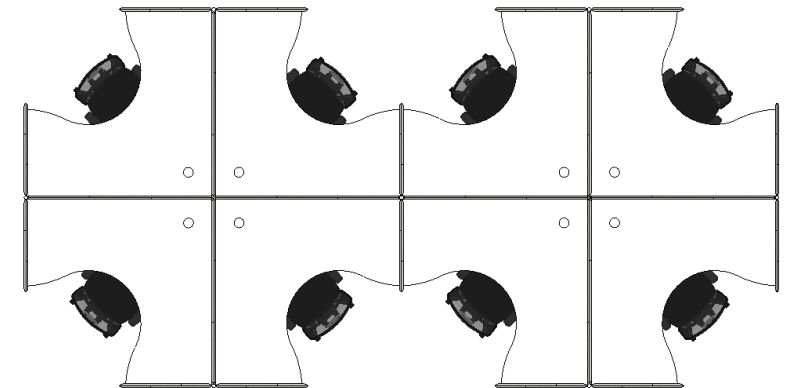
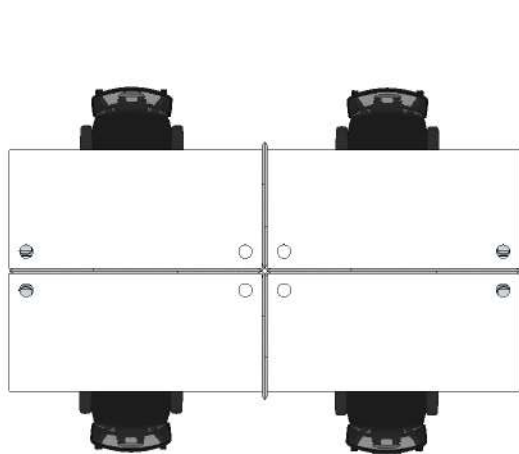

MAXIMISE SPACE WITH OPEN WORKSTATIONS

SPREAD OUT WITH A 3 WAY 120° WORKSTATION

4 WAY WORKSTATION FOR MAXIMUM DESK SPACE

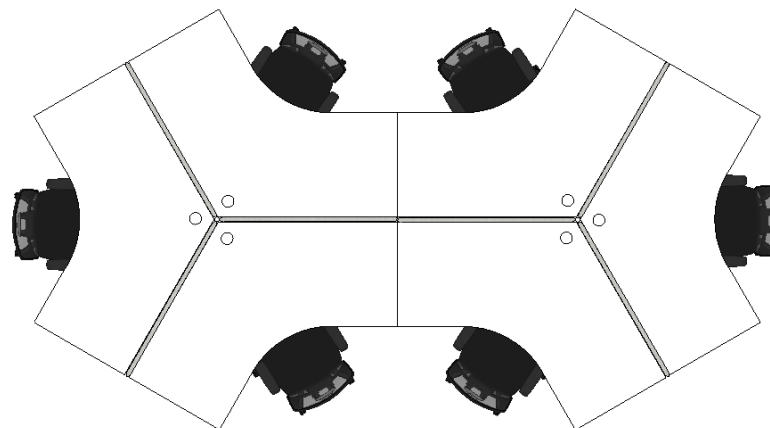

# RAPID SCREEN

## WORKSTATION TOP SIZES



## WORKSTATION TOP COLOURS

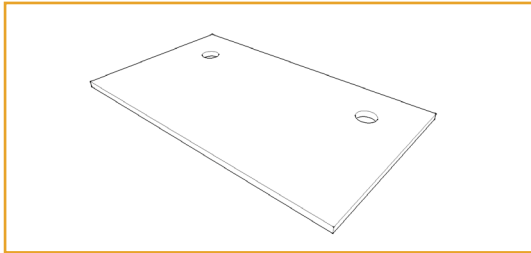

1200mm W x 700mm D x 25mm T

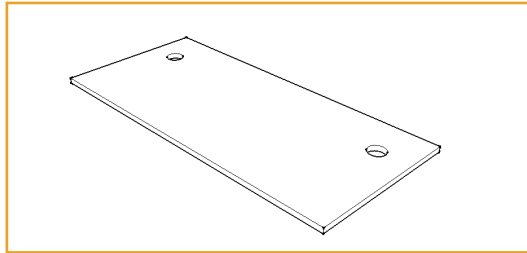

1500mm W x 700mm D x 25mm T

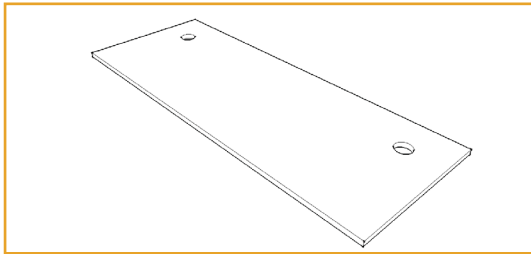

1800mm W x 700mm D x 25mm T

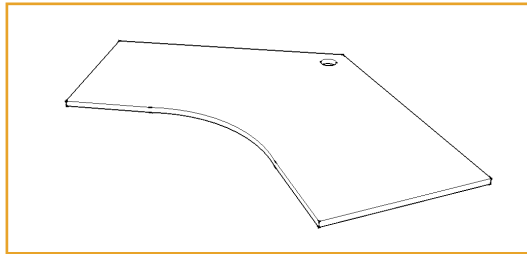

1200mm x 1200mm W x 700mm D x 25mm T

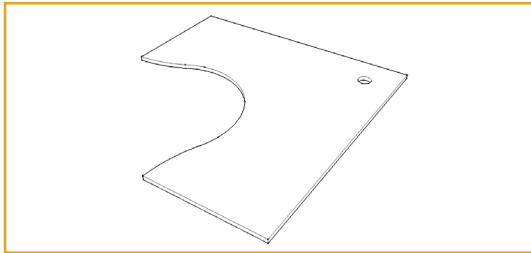

1500mm x 1500mm W x 700mm D x 25mm T

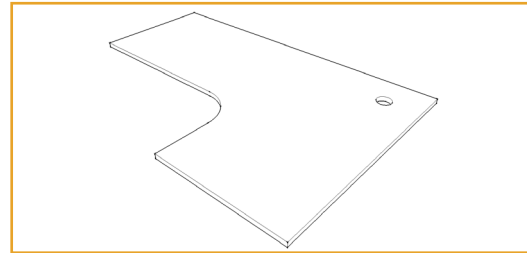

1800mm x 1200mm W x 700mm D x 25mm T

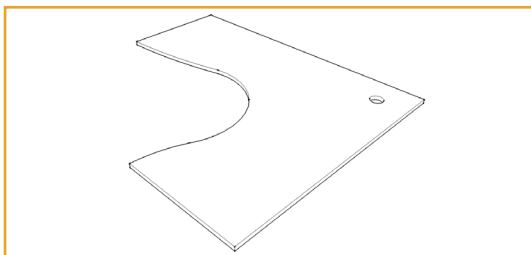

1800mm x 1500mm W x 700mm D x 25mm T

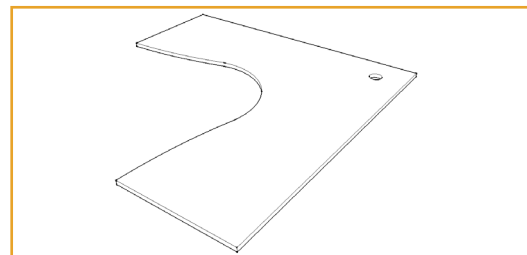

1800mm x 1800mm W x 700mm D x 25mm T

## SCREEN HEIGHTS



1250mm HIGH SCREEN    1650mm HIGH SCREEN

750mm, 1200mm, 1500mm or 1800mm W  
x 1250mm or 1650mm H x 30mm T

## SCREEN COLOURS



## WORKSTATION LEG SYSTEMS

### SPAN LEGS

705mm H x 560mm D

Adjustable feet and cable management in leg



**SPLEG**  
White



**SPLEG**  
Black



**SPLEG**  
Precious Silver

### ADJUSTABLE LEG

650 - 800mm H

Tapered DIA. 65 to 50mm



**AD LEG**  
White or Precious Silver

### C LEG

705mm H x 550mm D

Adjustable feet

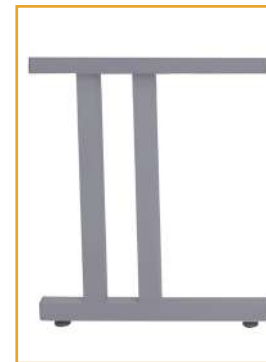

**C LEG**  
Precious Silver

### DC-60 POLE LEGS

60mm DIA. x 705mm H Round

Leg with Adjustable Foot



**DC-60 LEG**  
Chrome, Black or White

**NEW**

## SCREEN ACCESSORIES



900mm Shelf  
Shown with Brackets



4 Space Document Divider



Document Tray

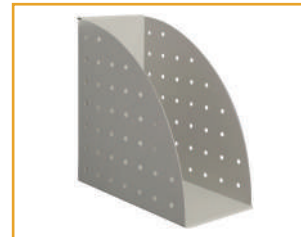

File Holder



### JOINING POLES

1250mm or 1650mm High  
Link screens at 90, 180 or  
120 degrees. Use in corners  
or to join return screens.



Double Pen Holder



Triple Pen Holder



Free Standing Foot



Wall Starter



# RAPID SPAN WHITE

## WHITE & SILVER CLEG DESK



1200 x 700   1500 x 700   1800 x 700  
 Desk & Return 1800 x 700 / 1100 x 600

- Perforated Metal or Melamine Modesty Panels
- Image above: White Top, White Melamine Modesty Panel and Silver C Legs.

## WHITE & SILVER CORNER WORKSTATION



1500 x 1500 x 700   1800 x 1200 x 700  
 1800 x 1500 x 700   1800 x 1800 x 700

- Perforated Metal or Melamine Modesty Panels
- Image above: White Top, Silver Metal Modesty Panel and Silver Span Legs.

## WHITE & SILVER SPAN DESK WITH RETURN



Desk & Return 1800 x 700 / 1100 x 600

- Perforated Metal or Melamine Modesty Panels
- Image above: White Top with Return, Silver Melamine Modesty Panels and Silver Span Legs.

## WHITE & WHITE SPAN DESK



1200 x 700   1500 x 700   1800 x 700  
 Desk & Return 1800 x 700 / 1100 x 600

- Perforated Metal or Melamine Modesty Panels
- Image above: White Top, White Metal Modesty Panel and White Span Legs.

## WHITE & BLACK CORNER WORKSTATION



1500 x 1500 x 700   1800 x 1200 x 700  
 1800 x 1500 x 700   1800 x 1800 x 700

- Perforated Metal or Melamine Modesty Panels
- Image above: White Top, White Melamine Modesty Panel and Black Span Legs.

## WHITE & WHITE SPAN DESK WITH RETURN



Desk & Return 1800 x 700 / 1100 x 600

- Perforated Metal or Melamine Modesty Panels
- Image above: White Top with Return, White Metal Modesty Panel and White Span Legs.

### FRAME FINISHES

Silver
White
Black



## WORKSTATION TOP SIZES

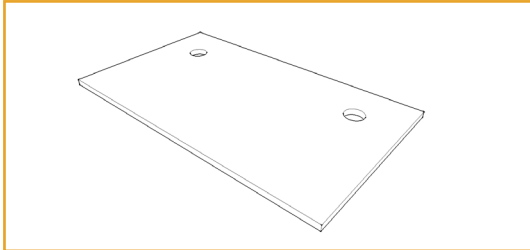

1200mm W x 700mm D x 25mm T

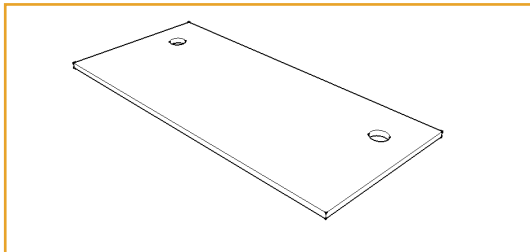

1500mm W x 700mm D x 25mm T

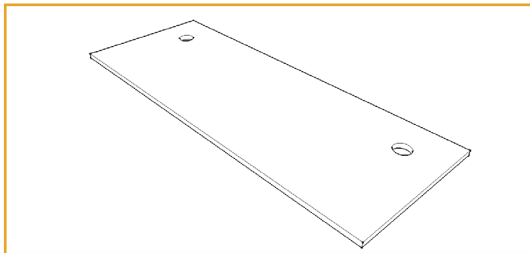

1800mm W x 700mm D x 25mm T

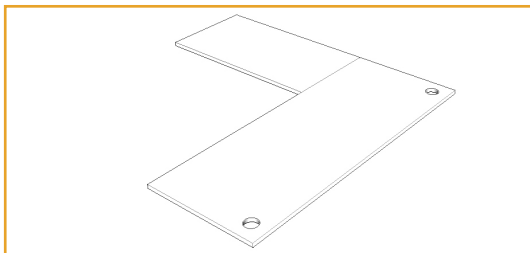

1800mm W x 700mm D / 1100mm W x 600mm D

## E1 ENVIRO BOARD

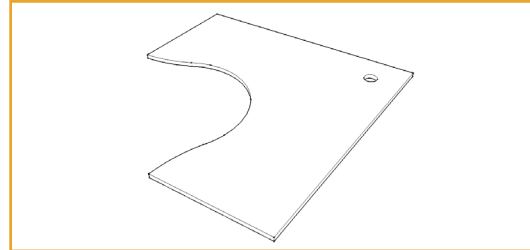

1500mm x 1500mm W x 700mm D x 25mm T

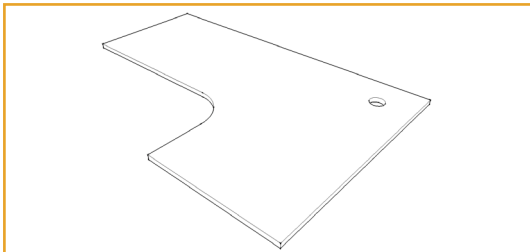

1800mm x 1200mm W x 700mm D x 25mm T

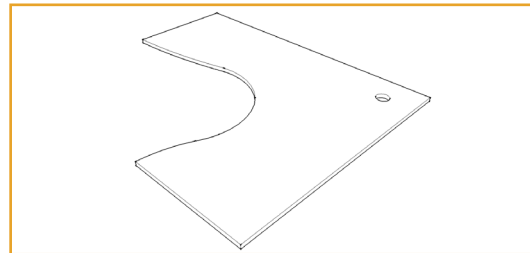

1800mm x 1500mm W x 700mm D x 25mm T

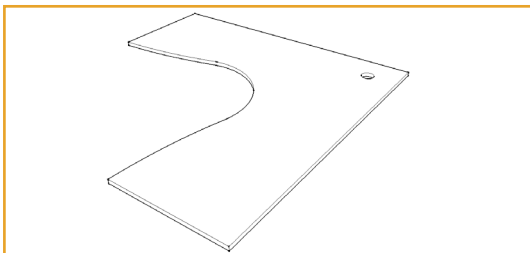

1800mm x 1800mm W x 700mm D x 25mm T

## TOP FINISHES

Beech

Warm White

## MODESTY FINISHES

White Perforated Metal

Black Perforated Metal

Silver Perforated Metal

Beech Melamine

Warm White Melamine



# RAPID SPAN WHITE

## Rapid Span Workstation System

Create a modern, clean office space with the Rapid Span white workstation and matching furniture range.



### MODESTY PANEL STYLES



Metal Modesty Panel with Perforated Detail



Melamine Modesty Panel to match Desk Top

### WORKSTATION LEG SYSTEMS

#### SPAN LEGS - SPLEG

705mm H x 560mm D

Adjustable feet and cable tidy in leg



#### C LEG

705mm H x  
550mm D  
Adjustable feet

### WORKSTATION EXAMPLES



- Warm White Top, White Perforated Metal Modesty & White Span Legs



- Warm White Top, Black Perforated Metal Modesty & Black Span Legs



- Warm White Tops, Grey 1250H Screens, Perforated Metal Modesty and Span Legs in Silver



## Rapid Span Furniture

Matching furniture and storage range to compliment any Rapid Span white desk or workstation.



CREDENZA



Includes 2 Adjustable Shelves  
**SPC12** 1200W x 450D x 730H  
**SPC18** 1800W x 450D x 730H

HUTCH



Includes Adjustable Shelves  
**SPH12** 1200W x 315D x 1070H  
**SPH18** 1800W x 315D x 1070H

SILVER FRAME MEETING



Rectangular Shaped Top with White Top and Silver Frame  
**RST189W** 1800W x 900D x 730H  
**RST1875W** 1800W x 750D x 730H

MOBILE PEDESTAL



447W x 465D x 690H  
 Lockable Mobile Pedestal  
**SPMP3** 3 Drawers

CUPBOARD



Lockable, 1 Fixed, 3 Adjustable Shelves  
**SP2FD18** 900W x 450D x 1800H

BOOKCASE



Includes Adjustable Shelves  
**SPBC12** 900W x 315D x 1200H  
**SPBC18** 900W x 315D x 1800H

TYPHOON BOARDROOM



Typhoon Boardroom Table, Black and Chrome Frame  
**TTR189** 1800 x 900 x 750H Twin Post, Single Stage Frame  
**TTR2412** 2400 x 1200 x 750H Twin Post, Single Stage Frame  
**TTR3212** 3200 x 1200 x 750H Twin Post, Dual Stage Frame

FINISHES

Warm White

NEW



4 STAR ROUND



4 Star Silver Round Base  
**RSRT6** 600mm DIA. Top  
**RSRT9** 900mm DIA. Top  
**RSRT12** 1200mm DIA. Top

TYPHOON ROUND



Typhoon 4 Star Base Round Table  
 Black and Chrome Base with White Top  
**TTR900** 900mm DIA. Top  
**TTR1200** 1200mm DIA. Top

NEW

# RAPID SPAN BEECH

BEECH & SILVER CLEG DESK



1200 x 700    1500 x 700    1800 x 700  
 Desk & Return 1800 x 700 / 1100 x 600

- Perforated Metal or Melamine Modesty Panels
- Image above: Beech Top, Silver Metal Modesty Panel and Silver C Legs.

BEECH & WHITE CORNER WORKSTATION



1500 X 1500 X 700    1800 X 1200 X 700  
 1800 X 1500 X 700    1800 X 1800 X 700

- Perforated Metal or Melamine Modesty Panels
- Image above: Beech Top, White Metal Modesty Panel and White Span Legs.

BEECH & SILVER SPAN DESK WITH RETURN



FRAME FINISHES
Silver
White
Black

Desk & Return 1800 x 700 / 1100 x 600

- Perforated Metal or Melamine Modesty Panels
- Image above: Beech with Return, Silver Metal Modesty Panels and Silver Span Legs.

BEECH & BLACK SPAN DESK



1200 x 700    1500 x 700    1800 x 700  
 Desk & Return 1800 x 700 / 1100 x 600

- Perforated Metal or Melamine Modesty Panels
- Image above: Beech Top, Black Metal Modesty Panel and Black Span Legs.

BEECH & BLACK CORNER WORKSTATION



1500 X 1500 X 700    1800 X 1200 X 700  
 1800 X 1500 X 700    1800 X 1800 X 700

- Perforated Metal or Melamine Modesty Panels
- Image above: Beech Top, Black Metal Modesty Panel and Black Span Legs.

BEECH & BLACK SPAN DESK WITH RETURN



Desk & Return 1800 x 700 / 1100 x 600

- Perforated Metal or Melamine Modesty Panels
- Image above: Beech Top with Return, Black Metal Modesty Panel and Black Span Legs.

## WORKSTATION TOP SIZES

## E1 ENVIRO BOARD

## TOP FINISHES

Beech

Warm White

## MODESTY FINISHES

White Perforated Metal

Black Perforated Metal

Silver Perforated Metal

Beech Melamine

Warm White Melamine

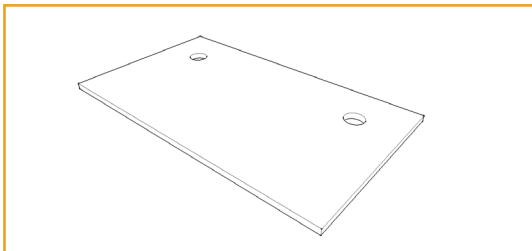

1200mm W x 700mm D x 25mm T

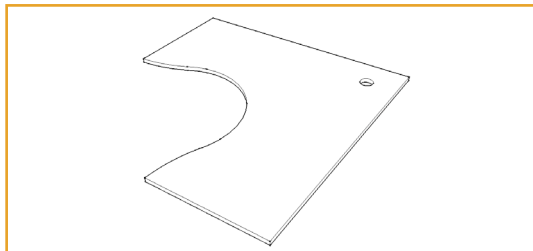

1500mm x 1500mm W x 700mm D x 25mm T

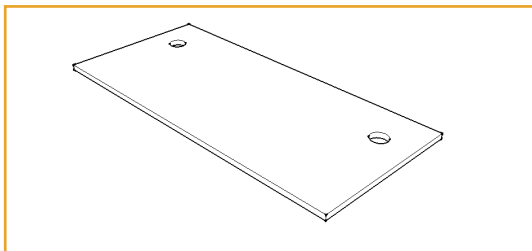

1500mm W x 700mm D x 25mm T

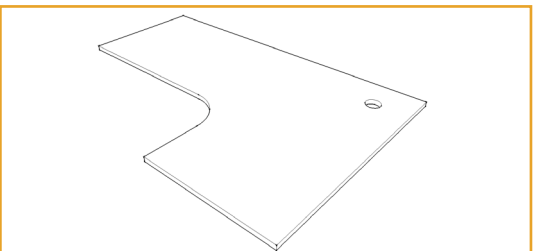

1800mm x 1200mm W x 700mm D x 25mm T

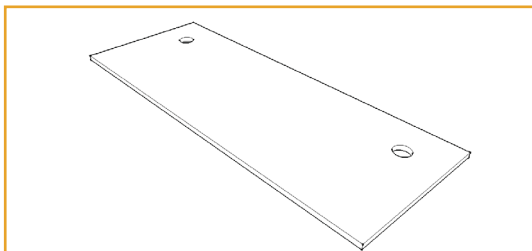

1800mm W x 700mm D x 25mm T

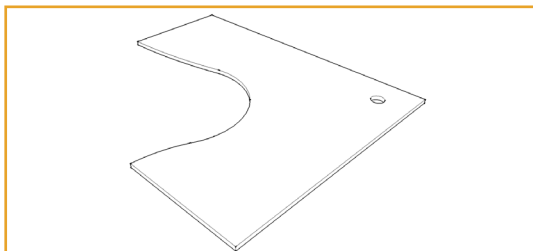

1800mm x 1500mm W x 700mm D x 25mm T

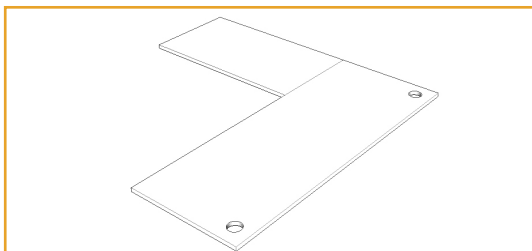

1800mm W x 700mm D / 1100mm W x 600mm D

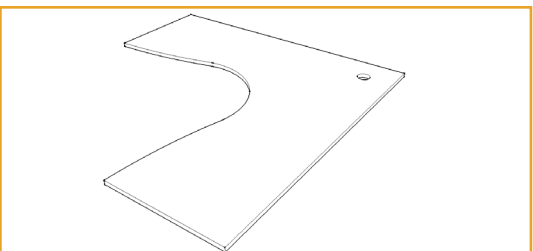

1800mm x 1800mm W x 700mm D x 25mm T



# RAPID SPAN BEECH

## Rapid Span Workstation System

Create a modern, clean office space with the Rapid Span beech workstation and matching furniture range.



### MODESTY PANEL STYLES



Metal Modesty Panel with Perforated Detail



Melamine Modesty Panel to match Desk Top

### WORKSTATION LEG SYSTEMS

#### SPAN LEGS - SPLEG

705mm H x 560mm D

Adjustable feet and cable tidy in leg



#### C LEG

705mm H x

550mm D

Adjustable feet

### WORKSTATION EXAMPLES



■ Beech Top, Silver Perforated Metal Modesty & Silver Span Legs



■ Beech Top, Black Perforated Metal Modesty & Black Span Legs



■ Beech Tops, Grey 1250H Screens, Perforated Metal Modesty and Span Legs in Silver





## Rapid Span Furniture

Matching furniture and storage range to compliment any Rapid Span beech desk or workstation.

**CREDENZA**



Includes Adjustable Shelves  
**SPC12** 1200W x 450D x 730H  
**SPC18** 1800W x 450D x 730H

**HUTCH**



Includes Adjustable Shelves  
**SPH12** 1200W x 315D x 1070H  
**SPH18** 1800W x 315D x 1070H

**SILVER FRAME MEETING**



Rectangular Shaped Top with Silver Frame and Beech Top  
**RST189B** 1800 x 900 x 730H  
**RST1875B** 1800 x 750 x 730H

**MOBILE PEDESTAL**



447W x 465D x 690H  
 Lockable Mobile Pedestal  
**SPMP3** 3 Drawers

**CUPBOARD**



Lockable, 1 Fixed, 3 Adjustable Shelves  
**SP2FD18** 900W x 450D x 1800H

**BOOKCASE**



Includes Adjustable Shelves  
**SPBC12** 900W x 315D x 1200H  
**SPBC18** 900W x 315D x 1800H

**TYPHOON BOARDROOM**



**FINISHES**  
 Beech

**NEW**

**WARRANTY 5 YEARS**

Typhoon Boardroom Table, Black and Chrome Frame  
**TTR189** 1800 x 900 x 750H Twin Post, Single Stage Frame  
**TTR2412** 2400 x 1200 x 750H Twin Post, Single Stage Frame  
**TTR3212** 3200 x 1200 x 750H Twin Post, Dual Stage Frame

**4 STAR ROUND**



4 Star Silver Round Base  
**RSRT6** 600mm DIA. Top  
**RSRT9** 900mm DIA. Top  
**RSRT12** 1200mm DIA. Top

**TYPHOON ROUND**



**NEW**

Typhoon 4 Star Base Round Table  
 Black and Chrome Base with Beech Top  
**TTR900** 900mm DIA. Top  
**TTR1200** 1200mm DIA. Top

# TABLES

## Tables

Extensive range of tables including boardroom, lounge, breakout, meeting, coffee tables and educational applications.

STEEL FRAME TABLE



Steel Frame Table  
40mm Black Legs with Adjustable Feet  
SFT126 1200W x 600D x 730H SFT1575 1500W x 750D x 730H  
SFT1875 1800W x 750D x 730H SFT189 1800W x 900D x 730H

FOLDING TABLE



25mm Melamine Top with 30mm Black Frame  
FFT1575 1500W x 750D x 730H  
FFT1875 1800W x 750D x 730H  
FFT189 1800W x 900D x 730H

FLIP TOP TABLE



Precious Silver Frame with Locking Castors  
Use with Table Links to Connect Multiple  
FTT1575 1500W x 750D x 730H  
FTT1875 1800W x 750D x 730H

TYPHOON FLIP TOP



Typhoon Flip Top Table  
Black and Chrome Finish  
TFT1575 1500W x 750D x 750H  
TFT1875 1800W x 750D x 750H

POLY FOLDING



Poly Folding Table  
White Plastic Top and Silver Frame  
PT1875 1800 x 750 x 730H  
PT209 2000 x 900 x 730H

RAPID EDGE FOLDING



Rapid Edge Folding Boardroom Table, 18mm Thick Top,  
Rubber Edging, Black and Chrome Frame, Locking Castors  
Driftwood or White Top, Includes Pair of Table Links  
FBT2410 2400 x 1000 x 743H

TOP FINISHES
Beech
Warm White
Cherry
Grey

NEW

NEW

FINISHES
Driftwood
Brilliant White





CHROME BASE ROUND



Chrome Base Round Table  
**CBT6** 600mm DIA. Top  
**CBT9** 900mm DIA. Top  
**CBT12** 1200mm DIA. Top

4 STAR ROUND



4 Star Silver Round Base  
**RSRT6** 600mm DIA. Top  
**RSRT9** 900mm DIA. Top  
**RSRT12** 1200mm DIA. Top

2.4M BOARDROOM



Rectangular Shaped Top with Ironstone Base  
 Available with White, Cherry or Appletree Top  
**CBT2412** 2400 x 1200 x 730H

**NEW**

IRONSTONE ROUND



Ironstone Base Round Table  
 Available with White, Cherry or Beech Top  
**CRM9** 900mm DIA. Top  
**CRM12** 1200mm DIA. Top

TYPHOON 4 STAR



Typhoon 4 Star Base Round Table  
 Black and Chrome Base  
**TTR900** 900mm DIA. Top  
**TTR1200** 1200mm DIA. Top

**NEW**

3.2M BOARDROOM



Rectangular Shaped 2 Piece Top  
 Available with Cherry, Beech or White Top  
**CBT3212** 3200 x 1200 x 730H

**NEW**



TYPHOON BOARDROOM



**NEW**

Typhoon Boardroom Table, Black and Chrome Frame  
**TTR189** 1800 x 900 x 750H Available with White, Beech, Cherry or Grey Top  
**TTR2412** 2400 x 1200 x 750H Available with White, Beech, Cherry or Appletree Top  
**TTR3212** 3200 x 1200 x 750H Available with White, Cherry or Beech Top

RAPID AIR BOARDROOM



**NEW**

Rapid Air Boardroom Table, Polished Aluminium Legs with Black Powdercoated Frame  
**RAB2412** 2400 x 1200 x 730H Available with White, Beech, Cherry or Appletree Top  
**RAB3212** 3200 x 1200 x 730H Available with White, Cherry or Beech Top



## High Tables

High tables for drafting, perfect for hospitality or creating breakout areas.

HIGH BAR TABLE



**NEW**

High Bar Rectangular Table - 1050mm High  
Black Powdercoated Frame, Adjustable Levelling Feet  
**HBT189** 1800 x 900 x 1050H Available with White, Beech, Cherry or Grey Top

TOP FINISHES
Beech
Warm White
Cherry
Grey

DRY BAR



Dry Bar Round Table - 1070mm High  
**CDBT6** 600mm DIA. Round Top x 1070H  
Available with White, Beech or Cherry Top

DRAFTING TABLE



900mm High Drafting Table in all Top Colours  
**9SFT1575** 1500 x 750 x 900H  
**9SFT189** 1800 x 900 x 900H



## Manual Height Adjustable Desk

Standalone manual height adjustable workstations, to adjust desk top height to suit user from sitting to standing position.

Low geared mechanism for ease of adjustment.

Universal crank handle, fold handle away when not in use.

FINISHES
Warm White

## Rapid Surge Adjustable Desk

Standalone gas lift operated height adjustable desks, to adjust desk top height to suit user from sitting to standing position.

Improve posture, back pain and risk of weight gain by simply adjusting your work top height.

FINISHES
White

MANUAL HEIGHT ADJUSTABLE

NEW



Manually Height Adjustable Desk  
 Desk Height from 715mm to 1015 mm  
 White Powdercoated Frame  
 Maximum Load 100kg  
 MHA  
 1200 W x 700 D  
 1500 W x 700 D  
 1800 W x 700 D  
 Available with White or Beech Top



RAPID SURGE HEIGHT ADJUSTABLE

NEW



Gas Lift Operated Height Adjustable Desk  
 Desk Height from 750mm to 1100mm  
 White Powdercoated Frame  
 Maximum Load 22kg  
 Control Levers Each Side  
 12 Different Height Settings  
 Worksurface Size:  
 1190 W x 590 D  
 Available with White Top and Frame



# RAPID SPAN ELECTRIC

## Rapid Span Electric Desks and Workstations

For many people a standard 730mm high desk height will not allow them to work comfortably and efficiently. When sharing workstations, a height adjustable workstation will be a valuable work tool to suit a range of users.

### STRAIGHT DESK



### PRODUCT CODES

SE 127 1200 W x 700 D  
 SE 157 1500 W x 700 D  
 SE 187 1800 W x 700 D

SE 15157 1500 x 1500 x 700 D  
 SE 18127 1800 x 1200 x 700 D  
 SE 18157 1800 x 1500 x 700 D  
 SE 18187 1800 x 1800 x 700 D

- Desk height 685 - 1205mm
- Maximum load 100kg
- Modesty panel for rigidity
- Stiffening rail for tops
- 31mm per second speed

TOP FINISHES
Beech
Warm White

FRAME FINISHES
Silver
White

### CORNER WORKSTATION



### COMPONENTS



#### SS-SPLEG

Frame in White or Precious Silver  
 Modesty Panel Optional Extra



#### SS-SPCNR

Corner Pole



#### SS-PSC

Optional Pre Set Control  
 3 Height settings for up to 3 users

## Paramount Height Adjustable Workstation System

The Paramount system exceeds expectations with stability, rigidity, strength and style.

The system provides full height adjustment from 630mm H to 1252mm H, and includes full cable management with an adaptable built in cable tray which also allows the option for power and data as an added extra.

SINGLE HEIGHT ADJUSTABLE



**NEW**

Single Height Adjustable Workstation  
Desk Height from 630 to 1252 mm  
White Frame and Top, Maximum Load 100 kg  
REP1P187  
1800 W x 750 D

SINGLE WITH SCREEN HEIGHT ADJUSTABLE



**NEW**

Single Height Adjustable Workstation with Screen  
Desk Height from 630 to 1252 mm, Black Screen 1350 to 1690mm H  
White Frame and Top, Maximum Load 100 kg  
REPWS1P187  
1800 W x 750 D

BACK TO BACK HEIGHT ADJUSTABLE



**NEW**

Back to Back Height Adjustable Workstation  
Desk Height from 630 to 1252 mm  
White Frame and Top, Black Screen 1350 to 1690mm H  
Maximum Load 100 kg  
REPWS2P187  
1800 W x 750 D

**E1 ENVIRO BOARD**



# RAPID RISER



## Rapid Riser

Height adjustable solution for on top of existing open or corner workstation. Generous size work surface, gas spring for smooth height adjustment and control levers each side. Built in tablet or phone holder and includes cable tie for any leads or cables. Grommet hole for monitor arm mounting.

RAPID RISER SMALL



Rapid Riser Small - White  
RR1 W 680 W x 590 D

RAPID RISER SMALL



Rapid Riser Small - Black  
RR1 B 680 W x 590 D

RAPID RISER MEDIUM



Rapid Riser Medium - White  
RR2 W 890 W x 590 D

RAPID RISER MEDIUM



Rapid Riser Medium - Black  
RR2 B 890 W x 590 D



## Monitor Arms

Attaches to your existing or new desk and allows movement of monitor to best suit users height and eyeline.

- 5kg capacity per arm
- Fits 10-27" monitors
- Vesa holes 100 x 100 or 75 x 75
- Audio, microphone and USB 3.0 ports

SINGLE MONITOR ARM



Single Monitor Arm  
SMARM 75-480mm Height Range

DUAL MONITOR ARM



Dual Monitor Arm  
DMARM 75-480mm Height Range

REVOLVE SINGLE ARM



NEW



Revolve Pole Mounted Single Arm  
RMA1 BL 260-360mm Height Range  
392mm Overall Height, Cable Management within Pole

REVOLVE DUAL ARM



NEW



Revolve Pole Mounted Dual Arm  
RMA2 BL 260-360mm Height Range  
392mm Overall Height, Cable Management within Pole

REVOLVE QUAD ARM



NEW



Revolve Pole Mounted Quad Arm  
RMA4 BL 260-360mm Height Range  
392mm Overall Height, Cable Management within Pole

ELEVATE ARM



NEW



Elevate Arm  
ELEVATE ARM 180-480mm Height Range  
Also Available in Black, Gas Operated



## The Rapid Vibe Range

All White or Grey finishes for a clean, fresh look, 25mm thick tops on all desks and workstations. Locking storage and metal runners in all drawers.

**E1 ENVIRO BOARD**

FINISHES	
Warm White	
Grey	

DESK



CDK1575 1500W x 750D x 730H  
CDK189 1800W x 900D x 730H

CORNER WORKSTATION



CWS1818 1800W x 1800W x 600D x 730H

DESK HOB



CHOB18N 1800W x 300D x 450H

HOME OFFICE DESK



CDK126 1200W x 600D x 730H  
HDKP1D Single Drawer Extra

LAPTOP DESK



CDK96 900W x 600D x 730H

MOBILE PEDESTAL



447W x 465D x 690H  
Lockable Mobile Pedestal  
SPMP3 3 Drawers

FIXED PEDESTAL



Optional Extra for Desks  
Lockable Fixed Pedestal  
CDKP3D 3 Drawers

DESK RETURN



Add to Straight Desks  
CR6 900W x 600D





## E1 ENVIRO BOARD

CREENZA



Includes 2 Adjustable Shelves  
**SPC12** 1200W x 450D x 730H  
**SPC18** 1800W x 450D x 730H

HUTCH



Includes Adjustable Shelves  
**SPH12** 1200W x 315D x 1070H  
**SPH18** 1800W x 315D x 1070H

CUPBOARD



Lockable, 1 Fixed, 3 Adjustable Shelves  
**SP2FD18** 900W x 450D x 1800H

BOOKCASE



Includes Adjustable Shelves  
**SPBC12** 900W x 315D x 1200H  
**SPBC18** 900W x 315D x 1800H



# RAPID WORKER



## The Rapid Worker Range

Sturdy, traditional, all melamine construction, 25mm thick tops on all desks and workstations. Locking storage and metal runners in all drawers.

**E1 ENVIRO BOARD**

FINISHES	
Beech	Ironstone
Cherry	Ironstone

DESK



CDK96	900W x 600D x 730H	
CDK126	1200W x 600D x 730H	
CDK1575	1500W x 750D x 730H	
CDK1875	1800W x 750D x 730H	* Drawers Not Included
CDK189	1800W x 900D x 730H	* Drawers Not Included

CORNER WORKSTATION



1200 x 1200 x 600D	1200 x 1500 x 600D	
1200 x 1800 x 600D	1200 x 2100 x 600D	
1500 x 1500 x 600D	1800 x 1500 x 600D	
1800 x 1800 x 600D	1800 x 1800 x 750D	* Drawers Not Included
2100 x 1500 x 600D	2100 x 1800 x 600D	* Drawers Not Included
2100 x 2100 x 600D		

DESK HOB



CHOB15N	1500W x 300D x 450H
CHOB18N	1800W x 300D x 450H

DESK RETURN



CR45	900W x 450D	
CR6	900W x 600D	* Drawers Not Included
CR12	1200W x 600D	* Drawers Not Included

FIXED PEDESTAL



CDKP1D1F	2 Drawers
CDKP3D	3 Drawers
CRP3D	Return

MOBILE PEDESTAL



447W x 465D x 690H	
CMP2F	2 Drawers
CMP2D1F	2 Drawers, 1 File
CMP4D	4 Drawers

MOBILE PEDESTAL



447W x 465D x 690H	
Ironstone ONLY	
Lockable Mobile Pedestal	
CMP2D1F-I	2 Drawers, 1 File

CREDENZA



CMZ1245	1200W x 450D x 730H
CMZ1545	1500W x 450D x 730H
CMZ1845	1800W x 450D x 730H

DRAWER



Ironstone ONLY  
No Lock  
HDKP1D 1 Drawer



## E1 ENVIRO BOARD

FINISHES	
Beech	Ironstone
Cherry	Ironstone



HUTCH

CH12 1200W x 315D x 1070H Includes 4 Shelves  
 CH15 1500W x 315D x 1070H Includes 4 Sheves  
 CH18 1800W x 315D x 1070H Includes 6 Shelves



PIGEON HOLE UNIT

20 Hole Unit - Includes 16 Shelves  
 PH20 1040W x 380D x 1040H



UTILITY TROLLEY

Ironstone ONLY  
 TR3 800W x 600D x 900H



CUPBOARD

Lockable, includes 4 Shelves  
 CSC2FD 900W x 450D x 1800H



LOCKABLE WALL UNIT

Lockable - Includes 4 Shelves  
 CSC2HD 900W x 450D x 1800H



BOOKCASE

CBC9 900W x 315D x 900H  
 CBC12 900W x 315D x 1200H  
 CBC18 900W x 315D x 1800H



FILING CABINET

Lockable  
 C3FC 465W x 600D x 990H  
 C4FC 465W x 600D x 1300H

# RAPID MANAGER



## The Rapid Manager Range

Classic dark wood style,  
Melamine or metal base desk options.  
Rounded corners on tops and full height modesty panel.



OPEN WORKSTATION

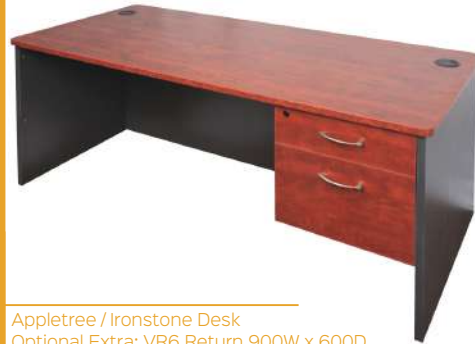

Appletree / Ironstone Desk  
Optional Extra: VR6 Return 900W x 600D  
Lockable Drawers Extra  
VDK1575 1500W x 750D x 730H  
VDK1875 1800W x 750D x 730H

CORNER WORKSTATION



Appletree / Ironstone Corner Workstation  
One Piece Top with Melamine Base  
VCW186 1800 x 1800 x 600D x 730H

FIXED PEDESTAL



465W x 447D x 454H  
Use with Ironstone Base  
VDKP1D1F 1 Drawer, 1 File  
VDKP3D 3 Drawers

OPEN WORKSTATION

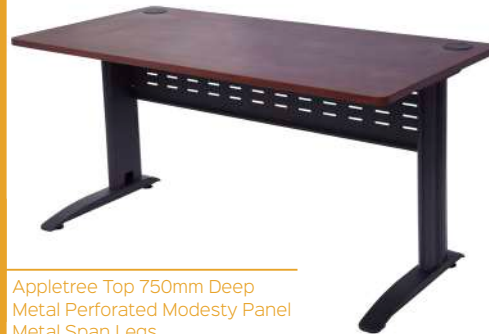

Appletree Top 750mm Deep  
Metal Perforated Modesty Panel  
Metal Span Legs  
VDKMB1575 1500W x 750D x 730H  
VDKMB1875 1800W x 750D x 730H

METAL BASE CORNER



Appletree One Piece Top 700mm Deep  
One Piece Top with Black Metal Base  
VCWMB186 1800 x 1800 x 600D x 730H



**FINISHES**  
 Appletree  
 Ironstone

HUTCH



Appletree / Ironstone Hutch Storage  
 Use with Melamine Base Desks  
**VH18** 1800W x 380D x 1050H

RAPID AIR BOARDROOM



Rapid Air Boardroom Table  
**RAB2412** 2400 x 1200 x 730H Available with Appletree Top  
 Also available with Melamine Base

TYPHOON ROUND



Typhoon 4 Star Base Round Table  
 Black and Chrome Base  
 900mm DIA. Top  
 1200mm DIA. Top

MOBILE PEDESTAL



447W x 465D 690H  
 Lockable Mobile Pedestal  
**VMP2D1F** 2 Drawers, 1 File

CUPBOARD



Lockable, includes 4 Shelves  
**VSC2FD** 900W x 450D x 1800H

BOOKCASE



Appletree Shelves with Ironstone Sides  
 Includes 4 Adjustable Shelves  
**VBC18** 900W x 315D x 1800H

FILING CABINET



Lockable  
 4 Drawers of Storage Space  
**V4FC** 465W x 600D x 1300H

HOB



Reception Hob ONLY  
 Add to Desk to create Reception Counter  
**VHOB18** Reception Hob

CREDENZA



Lockable Credenza  
**VCZ1245** 1200W x 450D x 730H  
**VCZ1845** 1800W x 450D x 730H



# NEW PRO MESH CHAIRS

## NEW MESH CHAIR SERIES



**FABRICS**  
Black



LUMINOUS

SW 480mm  
SD 545mm  
GH 420-510mm  
High Back Mesh Executive Chair with Synchro Mechanism, Adjustable Arms and Stylish White Frame

## 165KG WEIGHT RATING

**FABRICS**  
Black



ERGO



SW 520mm  
SD 490mm  
GH 450-540mm  
Fully Ergonomic with Seat Slide and Ratchet Back For Heavy Duty Use

**FABRICS**  
Black



HARTLEY TASK



SW 500mm  
SD 480mm  
GH 440-520mm  
Synchro Mech with Tension Control and Adjustable Arms

**FABRICS**  
Black



KAL



SW 500mm  
SD 510mm  
GH 430-520mm  
High Back with Lumbar Support, Synchro Mech and Adjustable Arms

**FABRICS**  
Black



HARTLEY VISITOR



SW 510mm  
SD 480mm  
BH 485mm  
Black Cantilever Frame Adjustable Arms Mesh Visitor Chair

## Chair Dimension Codes

SW = Seat Width

SD = Seat Depth

BH = Back Height

GH = Gas Height Range

**FABRICS**  
Black



ZOOM

ZOOM TABLET for use with Zoom Chair ONLY.



SW 460mm  
SD 490mm  
BH 330mm  
Mesh Back, Foldable Training and Conference Chair, with Optional Extra Foldable Tablet Arm.

# MESH CHAIRS

## Mesh Chair Range

Mesh Chairs not only provide excellent ventilation and breathability keeping the user cool, comfortable and dry, minimise the risk of muscular fatigue throughout the working day but also provide a modern, fresher looking workspace.

### Chair Dimension Codes

**SW** = Seat Width

**SD** = Seat Depth

**BH** = Back Height

**GH** = Gas Height Range

**EM300**

**FABRICS**  
Black Fabric  
Black PU



**WARRANTY 5 YEARS**

SW	490mm	Fully Ergonomic, Black
SD	440mm	Fabric or Black PU, Chrome
GH	460-590mm	Base Optional Extra

**AM300**

**FABRICS**  
Black



**WARRANTY 5 YEARS**

SW	525mm	High Back, Infinite Lock
SD	510mm	Tilt, Adjustable Arms and
GH	465-530mm	Polished Aluminium Base

**AM200**

**FABRICS**  
Black



**WARRANTY 5 YEARS**

SW	520mm	Medium Back, Infinite Lock
SD	500mm	Tilt, Adjustable Arms and
GH	420-520mm	Polished Aluminium Base

**AM100**

**FABRICS**  
Black



**WARRANTY 5 YEARS**

SW	470mm	Fully Ergonomic with
SD	490mm	Black Mesh Back
GH	460-550mm	Arms as Standard

**RIVER**

**FABRICS**  
Black



**WARRANTY 10 YEARS**

SW	480mm	Synchro Back and Seat Tilt Adjustment,
SD	470mm	Ratchet Back, Adjustable Arms
GH	460-570mm	Available as Optional Extra

**DAM**

**FABRICS**  
Black

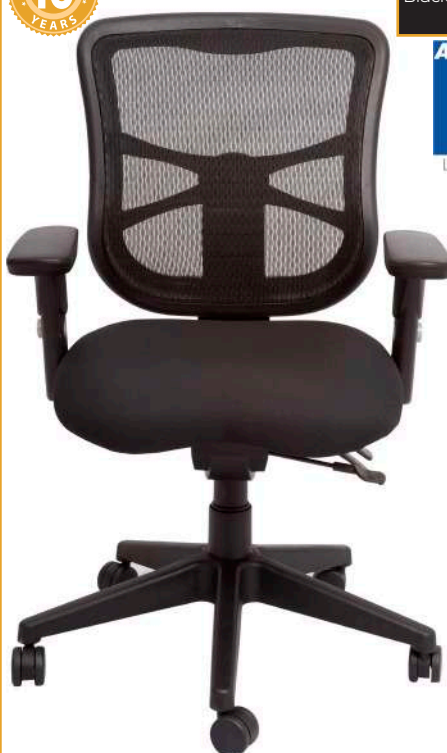

**WARRANTY 10 YEARS**

**AFRDI LEVEL 6**

SW	520mm	AFRDI Level 6, Fully Ergonomic with
SD	470mm	Tension Control, Heavy Duty Mesh,
GH	520-600mm	Ratchet Back, Spider Base and Arms

# MESH CHAIRS



WMCC

FABRICS  
Black

SW 470mm  
SD 470mm  
BH 500mm  
Mesh Back with Fabric Seat, Cantilever Chrome Frame and Arms

WM600



FABRICS  
Black Mesh



SW 510mm  
SD 420mm  
GH 480-590mm  
Ideal Meeting Chair with Chrome Base and Arms, Comfortable Mesh Material

VIENNA



FABRICS  
Black  
Red  
Lime  
Blue  
Silver



SW 490mm  
SD 490mm  
GH 430-550mm  
Mesh Back Chair Suitable for Home Office or Light Commercial Use

WMVBK



FABRICS  
Black



SW 480mm  
SD 480mm  
BH 480mm  
Mesh Back Visitor or Meeting Chair with Arms and Chrome Legs

VESTA



FABRICS  
Black



SW 460mm  
SD 460mm  
GH 430-530mm  
Mesh Back Chair with Fabric Seat, Suitable for Home Office Use

RE100



FABRICS  
Black



SW 510mm  
SD 500mm  
GH 470-590mm  
Plastic Perforated Back, Single Point Lock, Arms, Home Office Use

PMVBK



FABRICS  
Black



SW 455mm  
SD 460mm  
BH 300mm  
Mesh Back, Plastic Seat with Sled Base, Linking and Stacking Chair



# OPERATOR CHAIRS

## Operator Chair Range

High quality range of operator chairs to suit a range of users.

### Chair Dimension Codes

SW = Seat Width

SD = Seat Depth

BH = Back Height

GH = Gas Height Range



ET20  
SW 480mm  
SD 460mm  
GH 420-530mm  
Medium Back with Gas Lift, Back and Seat Tilt, Injection Moulded Foam



EC070CH  
SW 500mm  
SD 450mm  
GH 470-600mm  
High Back with Seat and Back Tilt, Gas Lift and Injection Moulded Foam

### OPTIONAL EXTRAS



ADJUSTABLE ARMS

DRAFTING KIT

CHROME BASE



EC070BM  
SW 500mm  
SD 450mm  
GH 470-600mm  
AFRDI Level 6, Medium Back, Back Tilt and Gas Lift



EC070BH  
SW 500mm  
SD 450mm  
GH 470-600mm  
High Back, Back Tilt, Gas Lift and Injection Moulded Foam Seat



EC070CM  
SW 500mm  
SD 450mm  
GH 470-600mm  
AFRDI Tested Level 6, Fully Ergonomic Medium Back Chair, Seat and Back Tilt, Gas Lift



EC070BM DRAFTING CHAIR  
SW 500mm  
SD 450mm  
GH 630-800mm  
Drafting Chair with Medium Back, Back Tilt, Gas Lift and Injection Moulded Foam for Comfort

# OPERATOR CHAIRS



130KG WEIGHT RATING

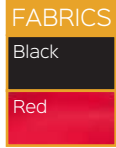

OPTIONAL EXTRAS



ADJUSTABLE ARMS

DRAFTING KIT

CHROME BASE



ST50



SW 500mm  
SD 470mm  
GH 460-600mm

AFRDI Level 6, Fully Ergonomic Operator Chair with Tapered Back and Ratchet Back Adjustment, Available in Black or Red Fabric, Adjustable Arms Optional Extra

EG100CH



SW 520mm  
SD 480mm  
GH 480-620mm

AFRDI Level 6, Fully Ergonomic with Back and Seat Tilt, Gas Lift, High Back, for User up to 130kg

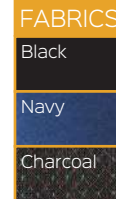

F300



SW 540mm  
SD 450mm  
GH 510-590mm

Fabric Operator Chair with Ratchet Back, Seat Slide, Chrome Base and Adjustable Arms

PU300



SW 540mm  
SD 450mm  
GH 510-590mm

Fully Ergonomic Soft PU Chair with Ratchet Back, Seat Slide, Chrome Base and Arms

## Chair Dimension Codes

SW = Seat Width

SD = Seat Depth

BH = Back Height

GH = Gas Height Range

## Operator Chair Range

High quality range of operator chairs and stools.

### Chair Dimension Codes

SW = Seat Width

SD = Seat Depth

BH = Back Height

GH = Gas Height Range

OPTIONAL EXTRAS



ADJUSTABLE ARMS



DRAFTING KIT



CHROME BASE

EG400



#### FABRICS

Black

Navy

Charcoal



PO500



#### FABRICS

Black

Navy

Charcoal

Black PU



DS DESK



#### FABRICS

Black PU

DS COUNTER STOOL



#### FABRICS

Black PU

SW 520mm  
SD 480mm  
GH 480-620mm

AFRDI Level 6, Fully Ergonomic with Back and Seat Tilt, Gas Lift, Square Back, for User up to 130kg

SW 530mm  
SD 510mm  
GH 490-590mm

AFRDI Tested Level 6, Fully Ergonomic High Back Chair, Seat and Back Tilt, Gas Lift

SW 400mm  
SD 400mm  
GH 450-570mm

400mm Round Seat Desk Stool, Easy to Clean Black PU Material

SW 400mm  
SD 400mm  
GH 650-870mm

400mm Round Seat Counter Stool, with Drafting Kit, Easy to Clean Black PU Material

# VISITOR CHAIRS



**NEW**



**FABRICS**  
Black



CL2000V



HARTLEY VISITOR

SW 510mm  
SD 480mm  
BH 485mm  
Mesh Back Visitor Chair with Comfortable Fabric Seat  
Black Cantilever Frame  
Adjustable Arms

**FABRICS**  
Black Leather



SW 510mm  
SD 500mm  
BH 630mm  
Slimline Cantilever Visitor  
Outward Adjust on Arms  
Chrome Arms and Base

**NEW**

**FABRICS**  
Black

WV100 BL



SW 440mm  
SD 430mm  
BH 450mm  
Comfortable Fabric Chair  
Chrome Sled Base

**FABRICS**  
Black

WMVBK



SW 480mm  
SD 480mm  
BH 480mm  
Mesh Back, Fabric Seat  
Visitor or Meeting Chair  
Chrome Legs and Arms

**FABRICS**  
Black  
Navy  
Charcoal

NOVA



SW 448mm  
SD 444mm  
BH 338mm  
Fabric Seat and Back  
Black Frame  
Linking and Stackable

## Chair Dimension Codes

SW = Seat Width  
SD = Seat Depth  
BH = Back Height  
GH = Gas Height Range



**FABRICS**  
Black

WMCC



SW 470mm  
SD 470mm  
BH 500mm  
Mesh Back, Fabric Seat  
Stylish Cantilever Frame  
Arms

## Chair Dimension Codes

SW = Seat Width

SD = Seat Depth

BH = Back Height

GH = Gas Height Range



FABRICS  
Black PU



SW 425mm  
SD 420mm  
BH 480mm

Stylish Black PU  
Chrome Frame  
Stackable

COMFO

FABRICS  
Black PU



SW 510mm  
SD 490mm  
BH 510mm

Visitor or Meeting Chair  
Chrome Frame  
Cantilever Base

V100

FABRICS  
Black  
Navy  
Charcoal



SW 450mm  
SD 450mm  
BH 460mm

Comfortable Fabric  
Visitor Chair  
Stackable

VSB600

FABRICS  
Black Fabric  
Black PU



SW 490mm  
SD 510mm  
BH 380mm

Heavy Duty Visitor or  
Meeting Chair, Black Sled  
Base and Padded Arms

P100

COLOURS  
Black



SW 450mm  
SD 370mm  
BH 405mm

Polypropylene Plastic  
Stacking Chair  
Available in Black or Grey



# EXECUTIVE CHAIRS

ENDURE 160



160KG WEIGHT RATING

FABRICS  
Black



NEW



SW 530mm High Back, Heavy Duty Task Chair  
SD 510mm Italian Synchro Mechanism,  
GH 460-560mm Suitable for User up to 160kg - "I42" Certification

CL410

FABRICS  
Black PU



SW 540mm Soft Black PU with Fabric  
SD 500mm Inlay, Infinite Tilt Lock,  
GH 450-550mm Chrome Base

CL610

FABRICS  
Black PU



SW 494mm Soft Black PU Upholstery,  
SD 500mm Single Point Tilt Lock,  
GH 450-580mm Medium Back Chair

CL710

FABRICS  
Black PU



SW 530mm Soft Black PU Upholstery,  
SD 530mm 4 Point Tilt Lock,  
GH 460-550mm High Back Chair

CL820

FABRICS  
Black PU



SW 520mm Soft Black PU Upholstery,  
SD 480mm Infinite Tilt Lock,  
GH 420-490mm Chrome Arms and Base

## Chair Dimension Codes

- SW = Seat Width
- SD = Seat Depth
- BH = Back Height
- GH = Gas Height Range



FABRICS  
Black Leather

CL2000H



SW 510mm High Back, Black Leather, Multi  
SD 500mm Position, Tilt Lock, Outward Adjust  
GH 500-565mm on Arms, Polished Aluminium Base

# EXECUTIVE CHAIRS

**CL2000M**

**FABRICS**  
Black Leather



**WARRANTY 10 YEARS**

SW 510mm Medium Back, Outward Adjust on Arms, Slimline,  
SD 500mm Multi Position Lock Tilt  
GH 500-565mm

**CL2000V**

**FABRICS**  
Black Leather



**WARRANTY 5 YEARS**

SW 500mm Cantilever Visitor, Slimline  
SD 500mm Chrome Frame, Outward  
BH 630mm Adjust on Arms

**PU605M**

**FABRICS**  
Black PU



**WARRANTY 5 YEARS**

SW 485mm Medium Back, Infinite Lock  
SD 460mm Tilt, Chrome Arms and  
GH 490-610mm Base, Black PU

**PU605H**

**FABRICS**  
Black PU



**WARRANTY 5 YEARS**

SW 485mm High Back, Infinite Lock  
SD 460mm Tilt, Chrome Arms and  
GH 490-610mm Base, Black PU

**LANDER**

**FABRICS**  
Black Leather



**WARRANTY 10 YEARS**

SW 510mm Fully Ergonomic, 3 Lever Heavy Duty Mechanism Executive  
SD 510mm Chair with Black Leather and Adjustable Arms as Standard  
GH 480-580mm Suitable for User up to 150kg and 24/7 Heavy Duty Use

## Chair Dimension Codes

**SW** = Seat Width

**SD** = Seat Depth

**BH** = Back Height

**GH** = Gas Height Range

**PU900M**

**FABRICS**  
Black PU



**WARRANTY 5 YEARS**

**NEW**

SW 520mm Medium Back with Upholstered Black  
SD 435mm PU Seat and Back, Single Point Lock,  
GH 460-545mm Polished Aluminium Base

# CONFERENCE & EVENTS CHAIRS

**WARRANTY 5 YEARS**



**FABRICS**  
Black

**GREENGUARD**  
PRODUCT CERTIFICATION FOR LOW VOC EMISSIONS IN CARPET, GLUE, INK, LEAD, AND PAINT  
GOLD

**NEW**

**ZOOM**



SW 460mm  
SD 490mm  
BH 330mm

Mesh Back with Back Rest Tilt, Foldable Training and Conference Chair, with Optional Extra Foldable Tablet Arm.

ZOOM TABLET for use with Zoom Chair ONLY.

**WIMBLEDON**



**COLOURS**  
Black

**BIFMA INTERNATIONAL**

**WARRANTY 3 YEARS**

SW 425mm  
SD 430mm  
BH 245mm

Plastic Seat and Back, Chrome Sled Base Linking and Stackable



Trolley available for ZEST, PMVBK, ZOLA, ZING and WIMBLEDON Chairs ONLY.

**ZOLA**



**COLOURS**  
Black

**WARRANTY 3 YEARS**

SW 460mm  
SD 440mm  
BH 200mm

Plastic Seat and Back Chrome Frame Stacking

**ZEST**



**COLOURS**  
Black

**WARRANTY 3 YEARS**

SW 445mm  
SD 450mm  
BH 310mm

Conference or Meeting Chair, Chrome Sled Base, Linking and Stackable

**ZING**



**COLOURS**  
Black

**BIFMA INTERNATIONAL**

**WARRANTY 3 YEARS**

SW 465mm  
SD 430mm  
BH 370mm

Large Back and Seat Optional Extra: Arms Linking and Stackable



## Chair Dimension Codes

SW = Seat Width

SD = Seat Depth

BH = Back Height

GH = Gas Height Range



### COLOURS

Black

White

Red



TAURUS BAR STOOL

SW 435mm  
SD 455mm  
BH 345mm

Indoor Hospitality Stool with Chrome Base, 750mm Seat Height, 1050mm Overall Height

LEO

### COLOURS

Black

White

Red



SW 420mm  
SD 410mm  
BH 420mm

Suitable for Indoor or Outdoor Use, Aluminium Legs

TAURUS

### COLOURS

Black

White

Red



SW 490mm  
SD 510mm  
BH 380mm

Indoor Hospitality Chair Chrome Base, Available in Red, Black or White

## Hospitality Chair Range

Compliment your café, lunch room or breakout areas with our comfortable and contemporary hospitality seating options.

PIPEE

### COLOURS

White

Grey

Green



SW 400mm  
SD 380mm  
BH 410mm

Polypropylene Plastic Stacking Chair, Holds up to 150kg, High Luster Shine



# OTTOMANS

## Ottoman Range

Soft Seating Ottomans provide communal, breakout and collaboration qualities to your office space. Choose from a variety of shapes, sizes & styles.

### Ottoman Dimension Codes

SW = Seat Width

SD = Seat Depth

H = Height

**NEW**

FABRICS  
Charcoal

MARS ROUND



SW	550mm	Upholstered Round
SD	550mm	Ottoman,
H	450mm	Charcoal Fabric

**NEW**

FABRICS  
Charcoal

MARS SQUARE



SW	550mm	Upholstered Square
SD	550mm	Ottoman,
H	450mm	Charcoal Fabric

**NEW**

FABRICS  
Charcoal

MARS TRIANGLE



SW	550mm	Upholstered Triangle,
SD	550mm	Ottoman,
H	450mm	Charcoal Fabric

FABRICS  
Black PU

VENUS OTTOMAN



SW	1030mm	Use as an Ottoman or Foot
SD	540mm	Stool, Black PU Finish and
H	410mm	Stainless Steel Frame

**NEW**

FABRICS  
Black PU

CONNECT 2 OTTOMAN



SW	320mm	Black Fabric Seat, White
SD	320mm	Powdercoated Steel
H	420mm	Base, User up to 110kg



## CORNER LOZENGE



Converts Desk and Return to a Corner Workstation  
Will fit 25mm or 33mm D Tops  
**LOZENGE25** 250W x 480L x 25D  
**LOZENGE33** 250W x 480L x 33D

## CHAIR MATS



Dimpled for use on Carpet, Smooth for Hard Floors  
**MAT S** Small Dimpled 915W x 1200L x 2D  
**MAT L** Large Dimpled 1140W x 1350L x 2D  
**MAT SM S** Small Smooth 915W x 1200L x 2D  
**MAT SM L** Large Smooth 1140W x 1350L x 2D

## DOUBLE SIDED WHITEBOARD



Double Sided Pivoting Mobile Whiteboard, includes Pen Tray  
**M129** 1200W x 900H x 15D  
**M159** 1500W x 900H x 15D  
**M189** 1800W x 900H x 15D

## CORKBOARDS



Composite Corkboard  
Aluminium Frame  
Suitable for Pins or Stickers  
**C96** 900W x 600H x 15D  
**C129** 1200W x 900H x 15D

## PINBOARDS



Includes 6 Pins

Grey Fabric Covered Commercial Pin Board,  
Brushed Aluminium Frame, Grey Fabric ONLY  
Wall Fix via Concealed Corner Fix  
**PIN96** 600W x 600H x 15D  
**PIN129** 1200W x 900H x 15D

## WALL MOUNTED WHITEBOARD



- Wall Mounted Aluminium Framed Magnetic Whiteboard
- Pen Tray
- Concealed Corner Fixing
- Acrylic Polyester Resin Surface
- 4 Magnets Included

**W96** 900W x 600H x 15D  
**W129** 1200W x 900H x 15D  
**W159** 1500W x 900H x 15D  
**W189** 1800W x 900H x 15D  
**W1812** 1800W x 1200H x 15D  
**W219** 2100W x 900H x 15D

## DESK MOUNTED SCREENS



Flat Top, Clamp or Screw Fix to Workstation, Pinable Fabric

**DMSF705** 700W x 500H x 30D  
**DMSF1205** 1200W x 500H x 30D  
**DMSF1505** 1500W x 500H x 30D  
**DMSF1805** 1800W x 500H x 30D

### SCREEN COLOURS

Grey

Blue

## ACOUSTIC SCREENS



Free Standing Dividing Office Panels, 50mm Thick, Pinable, Black PVC Edging and Silver Feet

**1515SCREEN** 1500W x 1500H x 50D  
**1518SCREEN** 1500W x 1800H x 50D  
**1815SCREEN** 1800W x 1500H x 50D  
**1818SCREEN** 1800W x 1800H x 50D

### SCREEN COLOURS

Grey

Blue



# STEEL STORAGE



## Personal Workstation Steel Storage Range

The Rapidline under desk storage range provides convenience, security and durability with ball-bearing drawer suspension, robust steel construction and anti-tilt mechanisms.

### RAPIDLINE MOBILE PEDESTAL



**COLOURS**

- Black Satin
- White China
- Precious Silver
- Graphite Ripple

Rapidline Mobile Pedestal  
Lockable, Full Extension Ball Bearing Runners,  
Flush Drawer Front, Fifth Wheel for Stability  
GMP3 3 Drawers 460W x 472D x 610H

### SLIMLINE MOBILE PEDESTAL



**COLOURS**

- White China

Slimline Mobile Pedestal  
Ideal for Smaller Workstations to allow for  
Extra Leg Room, Available in White ONLY.  
GSP3 3 Drawers 300W x 472D x 610H

### RAPIDLINE MOBILE CADDY



**COLOURS**

- White China

Rapidline Mobile Caddy - Available in White ONLY.  
Flush Front Mobile Pedestal with Tambour Door Section with Centre Shelf, Fully Lockable  
Ideal for Hot Desks or Workstation Return, Seat Cushion Available (Lead Time applies)  
GCAD L Tambour Door Left Hand 1050W x 460D x 570H  
GCAD R Tambour Door Right Hand 1050W x 460D x 570H



## Shelving Steel Storage Range

Declutter your office space and archive like a professional.

### RAPIDLINE SHELVING UNIT

**GSC9422** 2200H X 910W X 400D

- Flat packed, easy assembly
- Includes 5 shelves
- Available in Silver Grey only



#### COLOURS

Silver Grey

### RAPIDLINE BOLTLESS

**GV189** 1830H X 914W X 457D

**GV1812** 1830H X 1220W X 457D

- Heavy duty, includes shelves as shown
- Available in Silver Grey only

### RAPIDLINE MOBILE SHELVING

- Space Efficient Method of Bulk Storage
- Easy to Level and Relocate Base
- 110kg Shelf Capacity
- White Powdercoat Finish, Lockable

**4 BAY** 2670L X 980W X 2150H  
2670L X 1280W X 2150H

**6 BAY** 3560L X 980W X 2150H  
3560L X 1280W X 2150H

**8 BAY** 4450L X 980W X 2150H  
4450L X 1280W X 2150H

- With 4 Adjustable Shelves
- White only



#### COLOURS

White



# STEEL STORAGE

## LOCKERS



### SINGLE DOOR

**GL305/1** 305W x 455D x 1830H  
**GL380/1** 380W x 455D x 1830H  
 - 380W in Silver ONLY

- Riveted Construction for Extra Strength
- Fitted with Hat Shelf and Coat Rail
- Vented Doors



### 2 DOOR

**GL305/2** 305W x 455D x 1830H  
**GL380/2** 380W x 455D x 1830H  
 - 380W in Silver ONLY

- Riveted Construction for Extra Strength
- Fitted with Coat Hook to each Compartment
- Vented Doors



### 4 DOOR

**GL305/4** 305W x 455D x 1830H  
**GL380/4** 380W x 455D x 1830H  
 - 380W in Silver ONLY

- Riveted Construction for Extra Strength
- Full Length Stiffeners Fitted to each Door
- Vented Doors



### STEP LOCKER

Allows 2 Hanging Spaces in 380W Locker

- Available in Silver Grey ONLY.
- 380W x 455D x 1830H
- Vented Doors

**COLOURS**  
 White China  
 Silver Grey



### STAND ONLY SB2305

Stand ONLY for Bank of 2 x 305W Lockers  
**SB3305**

Stand ONLY for Bank of 3 x 305W Lockers



### 30° SLOPING TOP

**G12830** Single  
**G32830** Bank of 3

Available for 305W Lockers ONLY.



### BENCH SEAT BS1000

1000mm Wide Bench Seat  
 Silver Grey ONLY.



### SEAT & STAND S+S2305

Seat and Stand for Bank of 2 x 305W Lockers  
 Silver Grey ONLY.

### S+S3305

Seat and Stand for Bank of 3 x 305W Lockers  
 Silver Grey ONLY.

## GO TAMBOUR DOOR CUPBOARDS AND ACCESSORIES



**PLAIN SHELF**  
**GTD900** 900W  
**GTD1200** 1200W



**SLOTTED SHELF & DIVIDERS**  
**GG09SLOT** 900W  
**GG12SLOT** 1200W  
**GS7D** 5 Dividers



**PULL OUT SHELF**  
**GG09PS** 900W  
**GG12PS** 1200W



**CLIP ON DIVIDERS**  
**GSD6** 175H



**ROLL OUT FILING FRAME**  
**GG09FF** 900W  
**GG12FF** 1200W



**PLANTER BOX**  
**PB 900** 900W X 470D X 230H  
**PB 1200** 1200W X 470D X 230H



- (1016H, 1200H or 1981H) x (900W or 1200W) x 473D
- Adjustable feet, easy glide track and magnetic slam rail

### COLOURS

White China

Silver Grey

## GO LATERAL FILING CABINETS



### 2 DRAWER

**GLF2**  
 ▪ 705H X 900W X 473D



### 3 DRAWER

**GLF3**  
 ▪ 1016H X 900W X 473D



### 4 DRAWER

**GLF4**  
 ▪ 1321H X 900W X 473D



# STEEL STORAGE

## GO CUPBOARDS



**GCA10**  
1015H X 910W X 450D  
▪ Includes 2 Shelves

**GCA18**  
1830H X 910W X 450D  
▪ Includes 3 Shelves

**GCA20**  
2000H X 910W X 450D  
▪ Includes 4 Shelves

**GCWSG**  
Shelf and Coat Rail  
▪ Silver Grey only



- Flush Lock with 2 Keys
- Available assembled or flat pack
- Tested to British Standards
- Available in Silver Grey, Graphite Ripple or White

## GO STEEL FILING CABINETS



- Heavy duty, available in 4 Colours
- Fully Riveted with Ball Bearing Runners
- 40+ KG per drawer
- Tested to AFRDI Level 6

**GFCA2** 705H X 460W X 620D  
**GFCA3** 1016H X 460W X 620D  
**GFCA4** 1321H X 460W X 620D



COLOURS
Black Ripple
White China
Silver Grey
Graphite Ripple



## GO WARDROBE



**GO WARDROBE**  
1830H X 910W X 450D  
Hanging and Storage  
Space - Silver Grey only

## RAPIDLINE FILING CABINETS



- 30+ KG per drawer
- Ball Bearing Runners
- Commercial quality,
- Available assembled or flat pack
- Available in Silver Grey, White China and Graphite Ripple

**RFCA2** 675H X 464W X 620D  
**RFCA3** 980H X 464W X 620D  
**RFCA4** 1290H X 464W X 620D

COLOURS
White China
Silver Grey
Graphite Ripple

